

## Silicon N Channel Planar Power MOSFET

### Description

C

A

### General Features

- A
- A
- 
- 
- 
- 

### Application

- 
- 
- A

### Product Summar

### Absolute Maximum Ratings

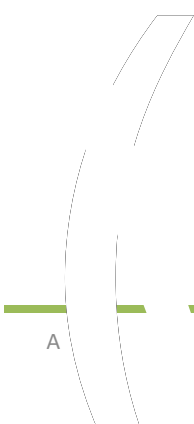

**Thermal Resistance**

**Electrical Characteristic** at Tj      C unless otherwise specified



**Static Characteristic**



**Dynamic Characteristic**

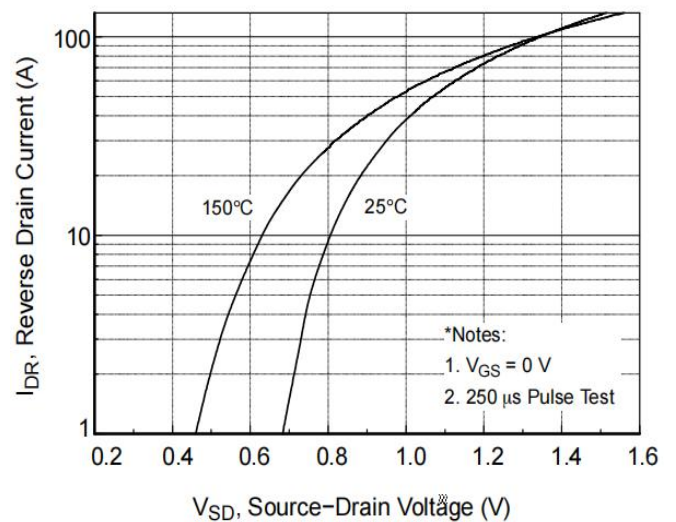
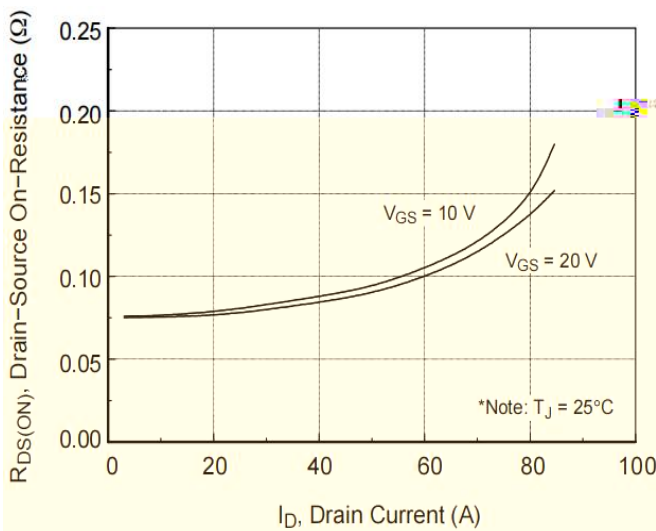
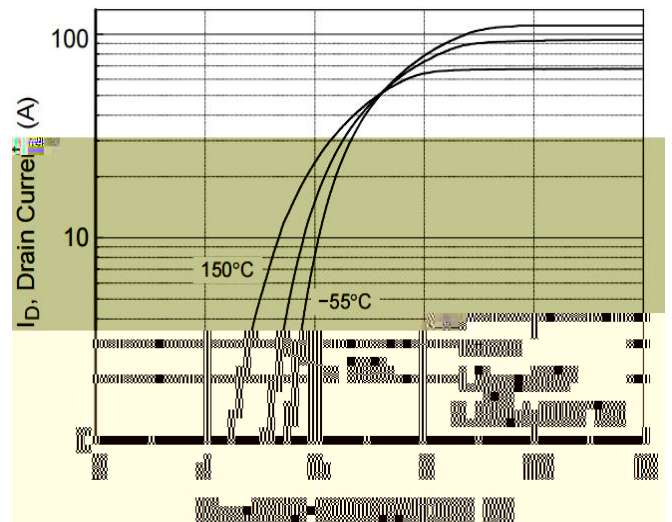
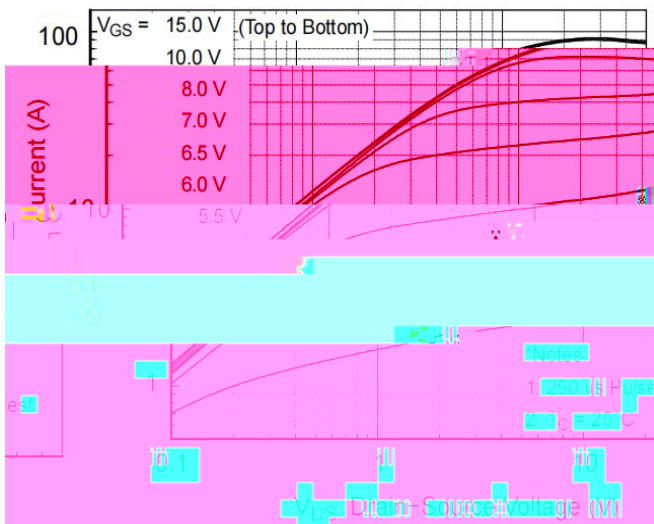

### Bod Diode Characteristic

Parameter	Symbol	Value			Unit	Test Condition
		min	typ	max		

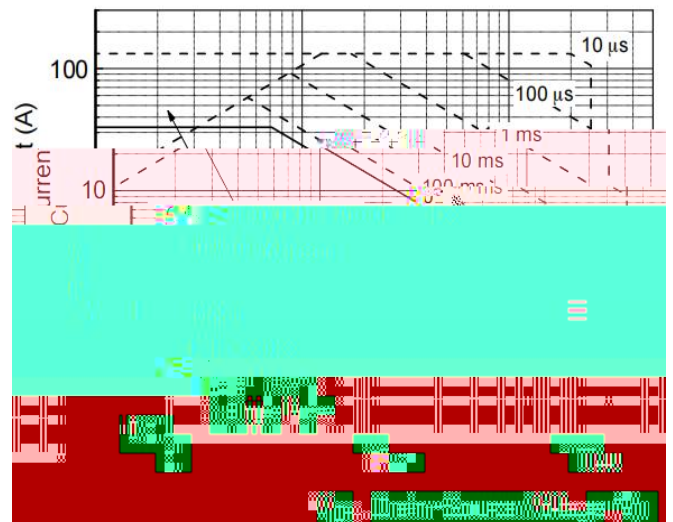
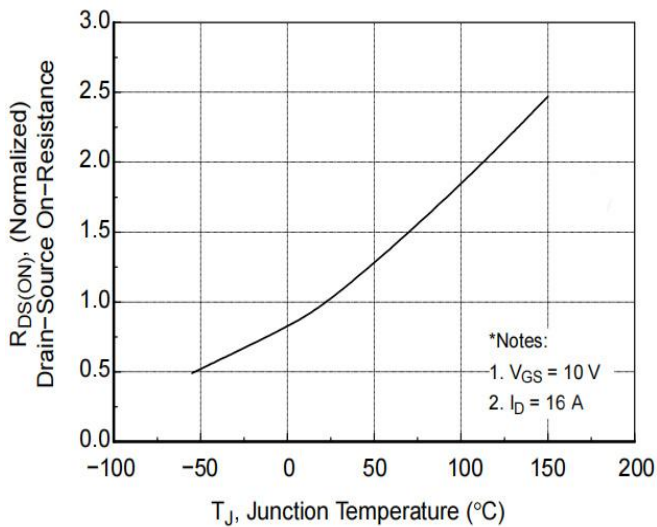
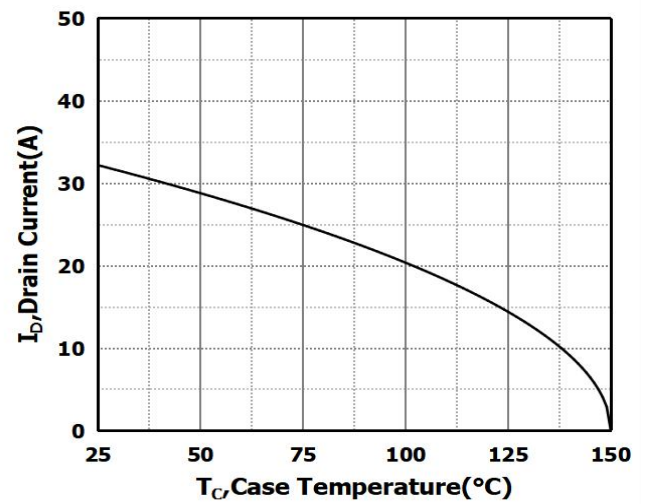
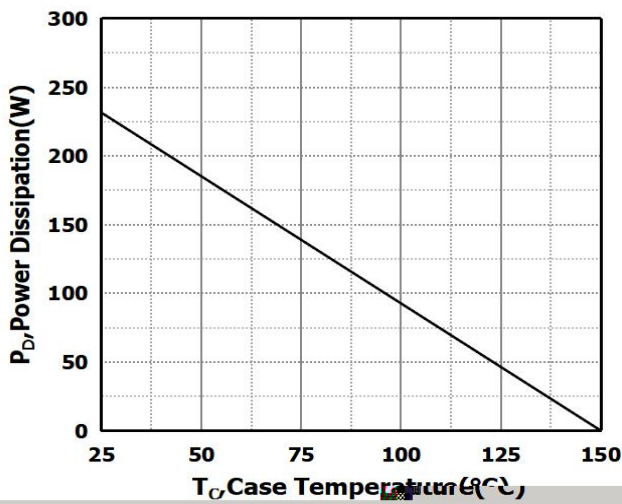
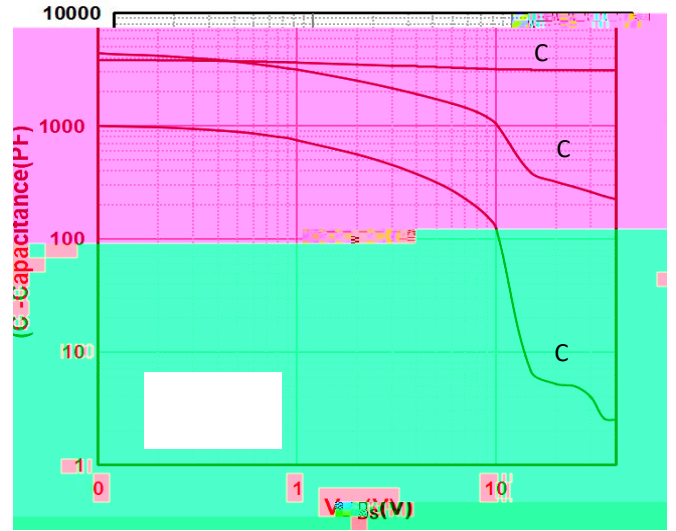
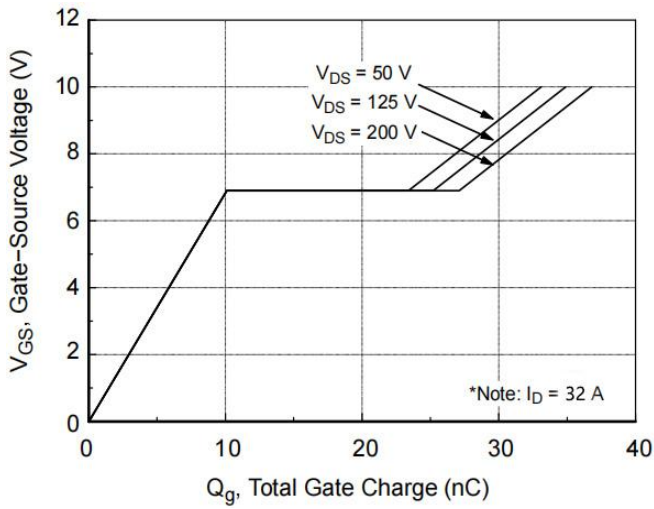
### Typical Performance Characteristics



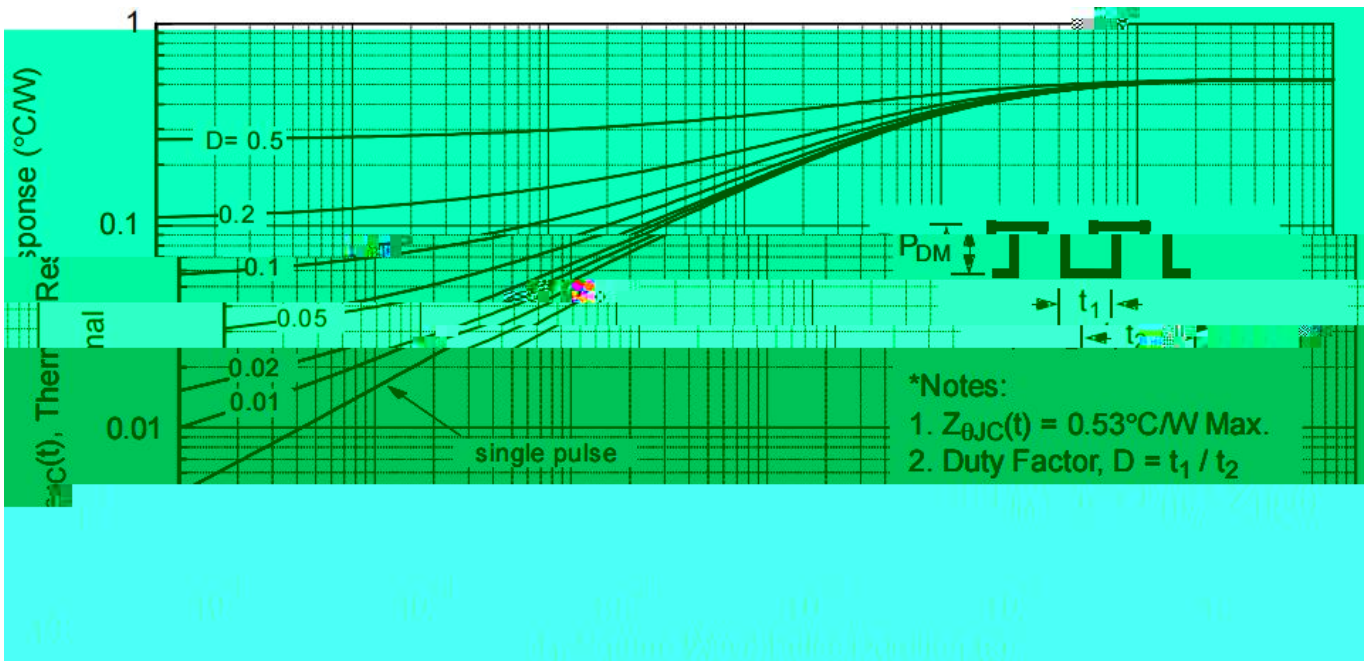



### Test Circuit & Waveform

Gate Charge Test Circuit & Waveform

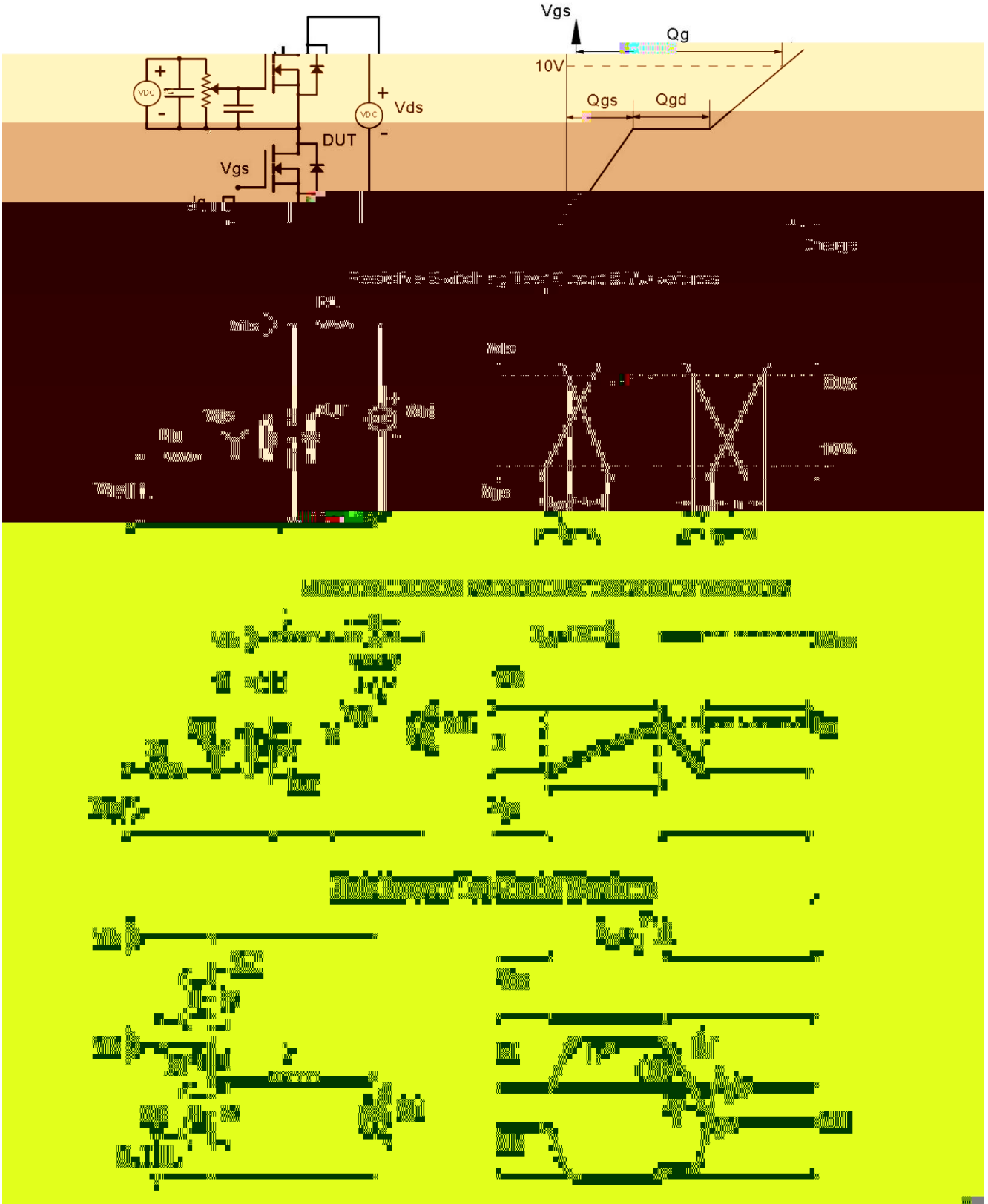

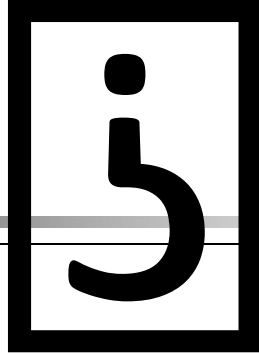

Package Information

TO C PACKAGE

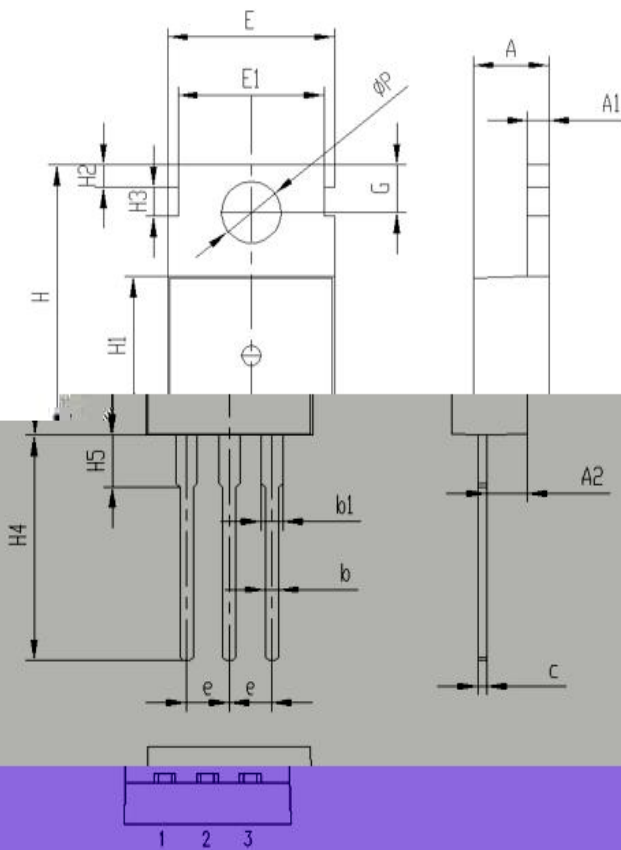

Symbol	单位 mm		
	Min	Nom	Max
A	4.30	4.5	4.70
A1	1.20	1.30	1.40
A2	2.20	2.4	2.60
b	0.60	0.8	1.00
b1	1.20	1.30	1.40
c	0.40	0.5	0.60
e	2.44	2.54	2.64
E	9.80	10.0	10.2
E1	8.50	8.70	8.90
H	15.5	15.7	15.9
H1	9.00	9.2	9.40
H2	1.10	1.34	1.50
H3	1.50	1.7	1.90
H4	12.9	13.3	13.7
H5	2.80	3.0	3.20
G	2.60	2.8	3.00
ΦP	3.40	3.6	3.80

Notice

) CE